



The democratisation of humanitarian mapping: insights into the MapSwipe app and data quality

Benjamin Herfort*

Melanie Eckle*, Marcel Reinmuth*, Pim de Witte, Pete Masters

**GIScience Research Group*

Heidelberg University



UNIVERSITÄT
HEIDELBERG
ZUKUNFT
SEIT 1386



HEIDELBERG INSTITUTE
FOR GEOINFORMATION
TECHNOLOGY



The MapSwipe App

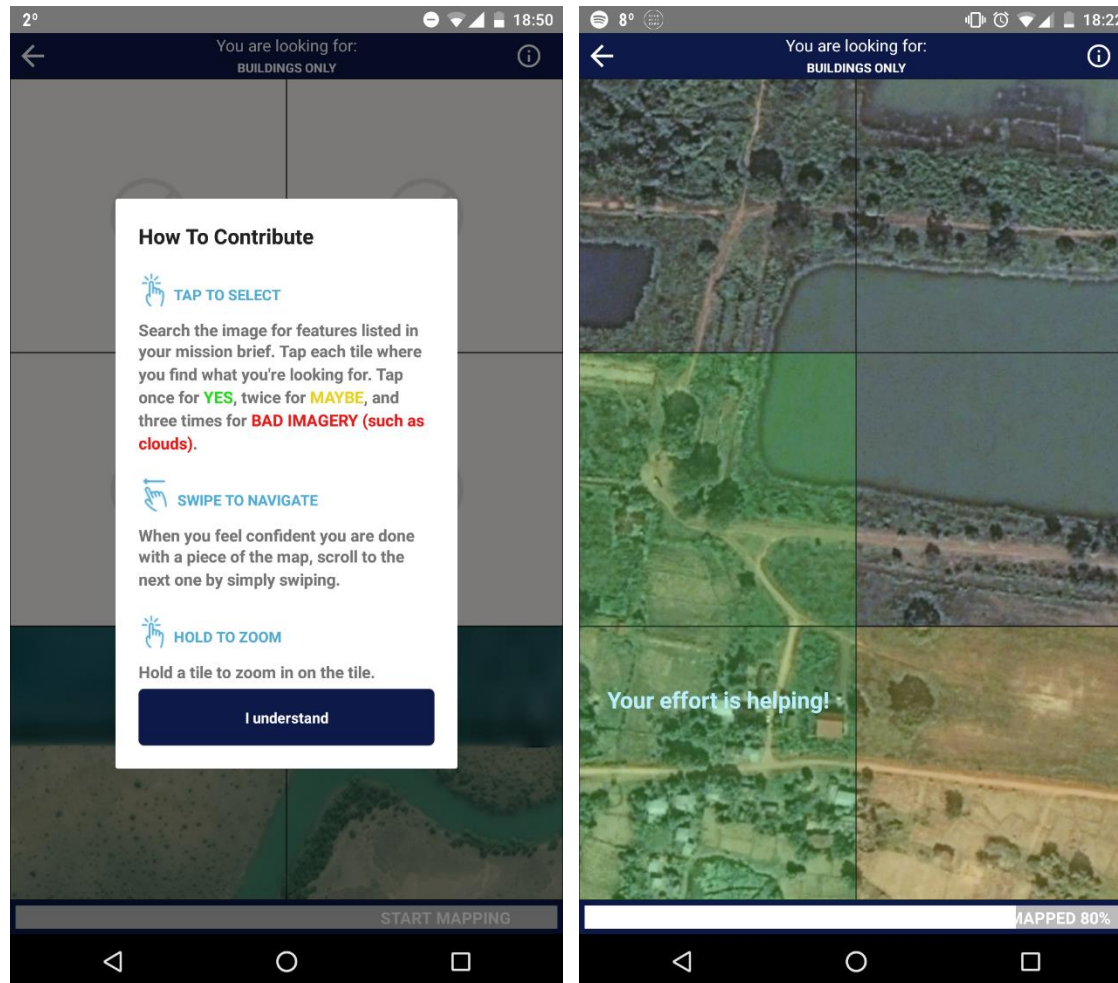

The MapSwipe workflow

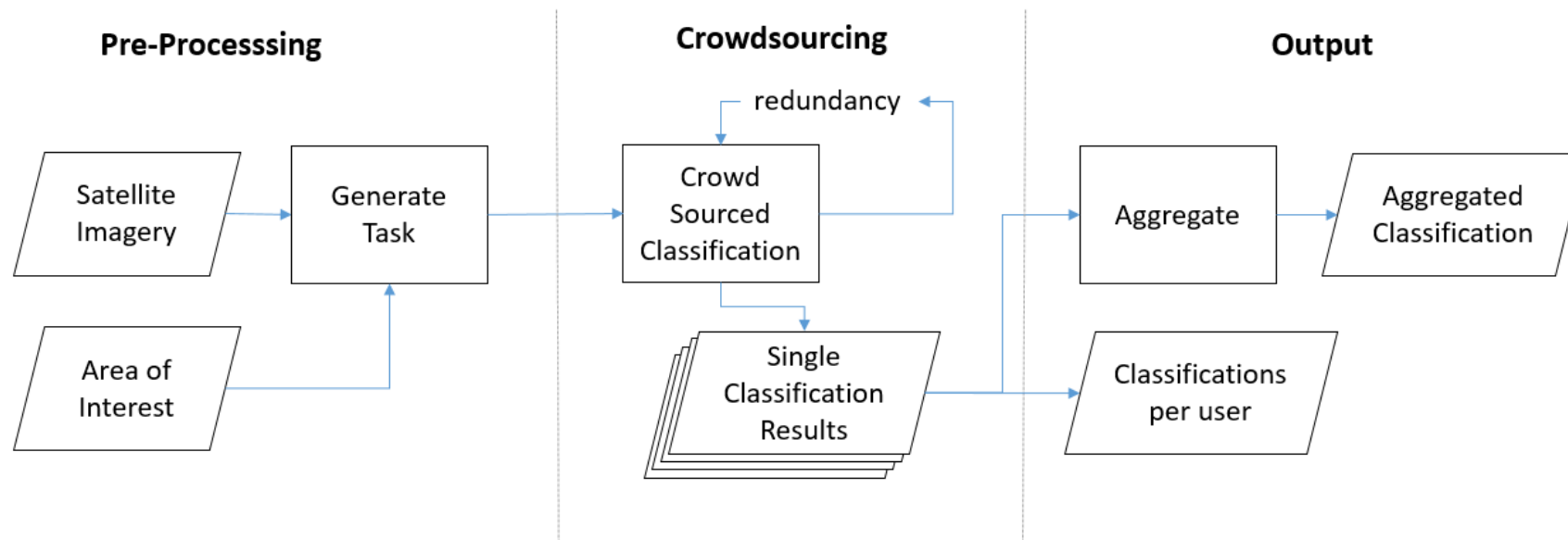

Albuquerque, J., Herfort, B., & Eckle, M. (2016). The Tasks of the Crowd: A Typology of Tasks in Geographic Information Crowdsourcing and a Case Study in Humanitarian Mapping. *Remote Sensing*, 8(10), 859. <https://doi.org/10.3390/rs8100859>

Case study: Madagascar

Name	Madagascar 1
Area (km ²)	6270.5
Groups	1,388
Tasks	278,688
Contributions	989,193
Users	867

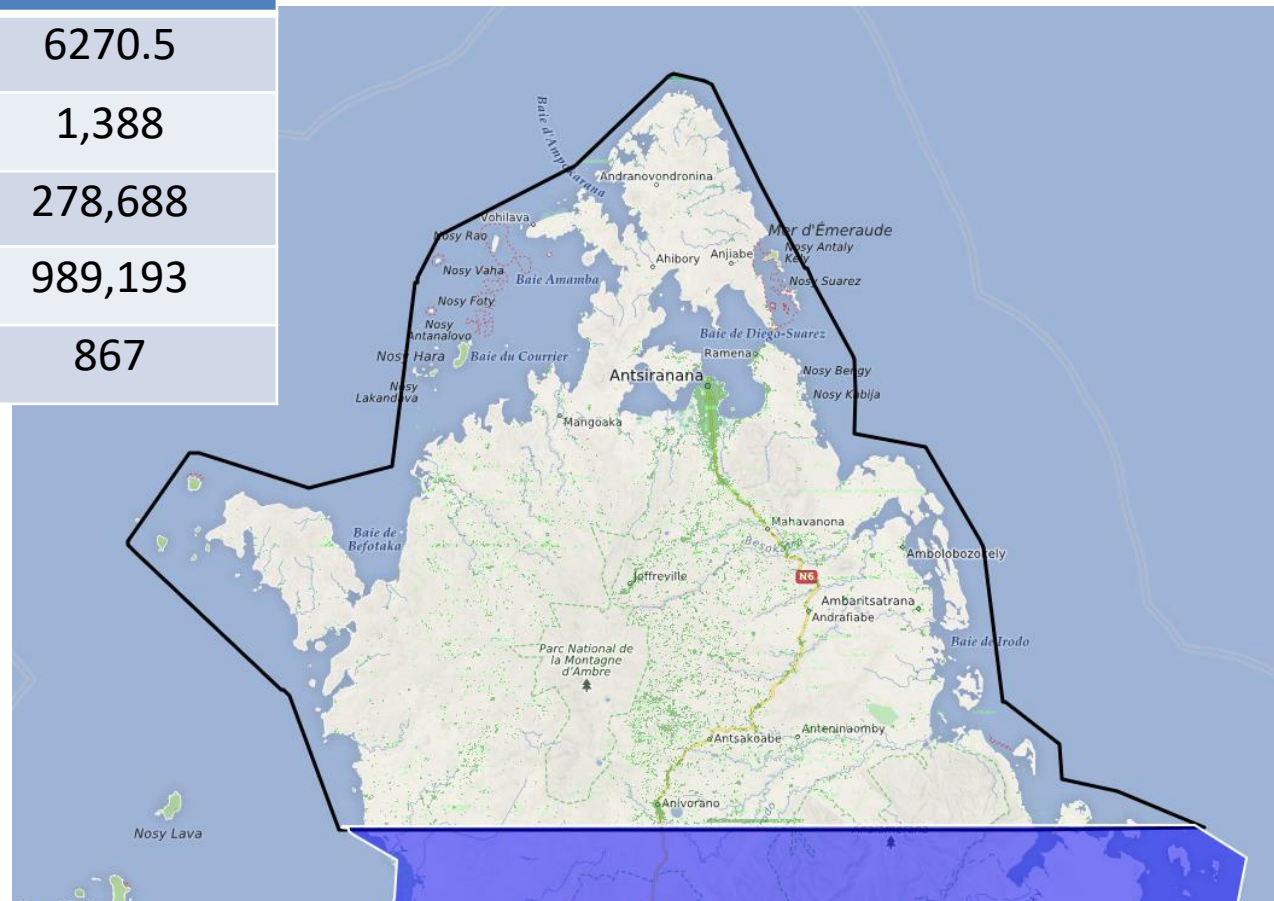

Case study: South Sudan

Name	South Sudan 1
Area (km²)	5800.3
Groups	1,286
Tasks	257,789
Contributions	874,418
Users	837

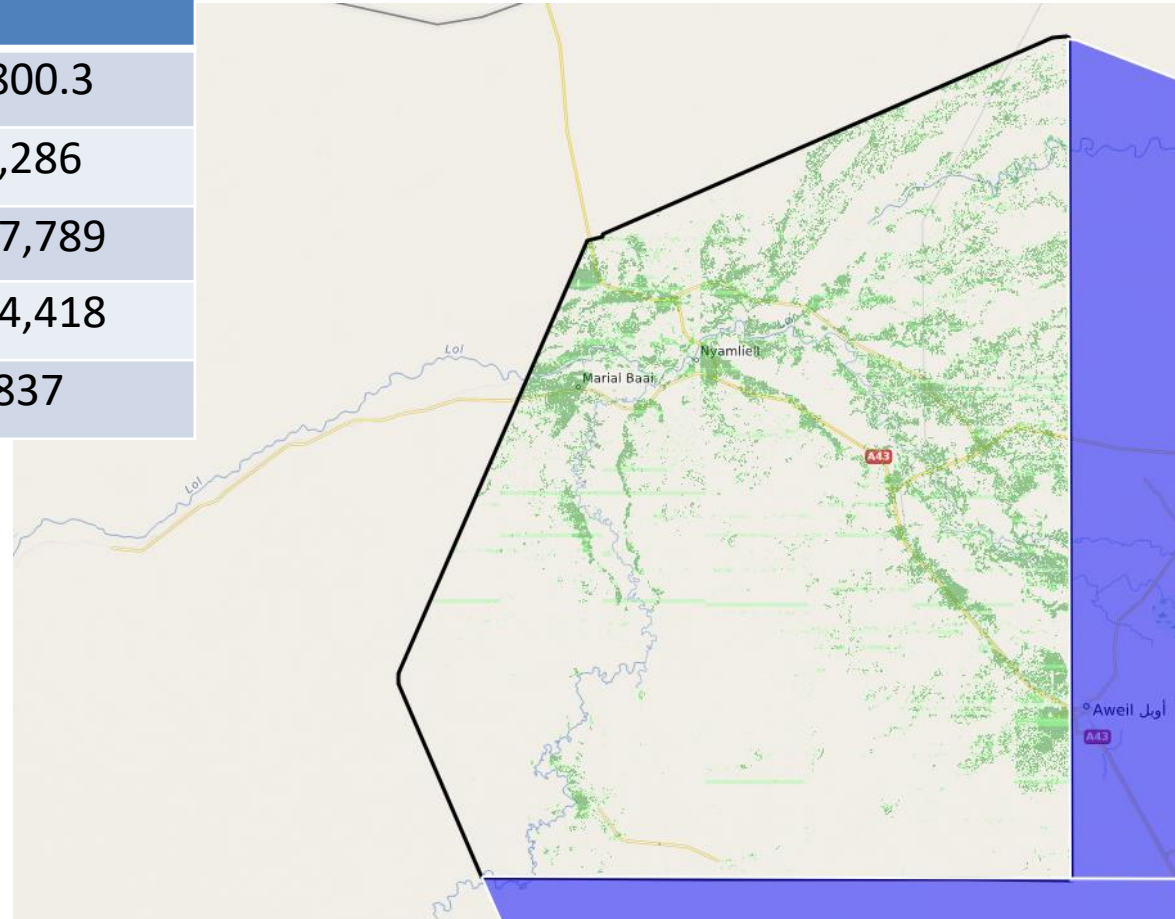

Inter-rater reliability per group

Madagascar

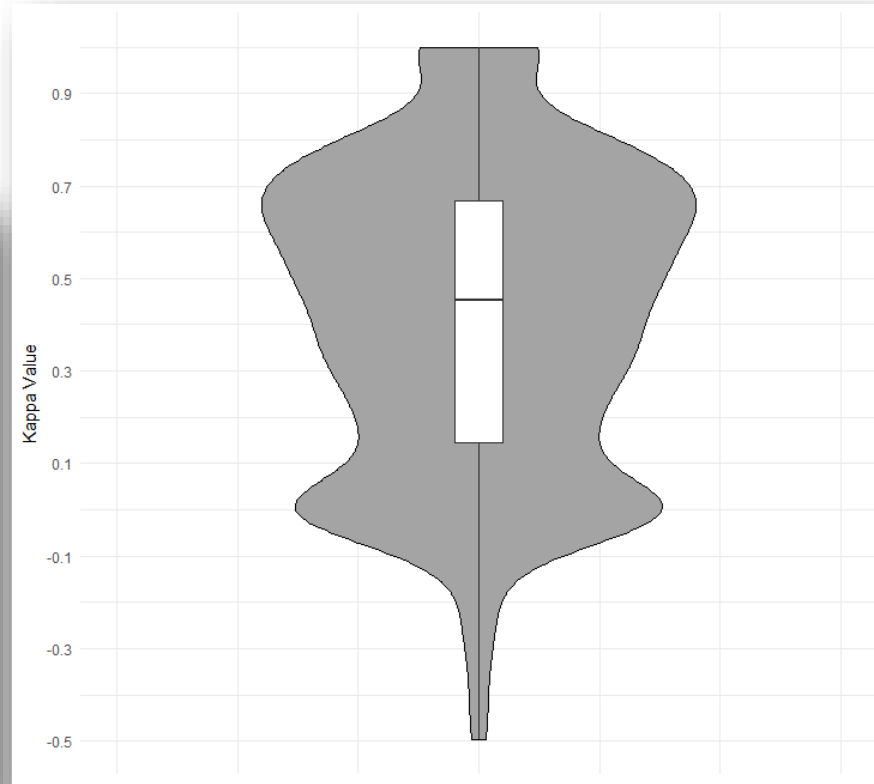
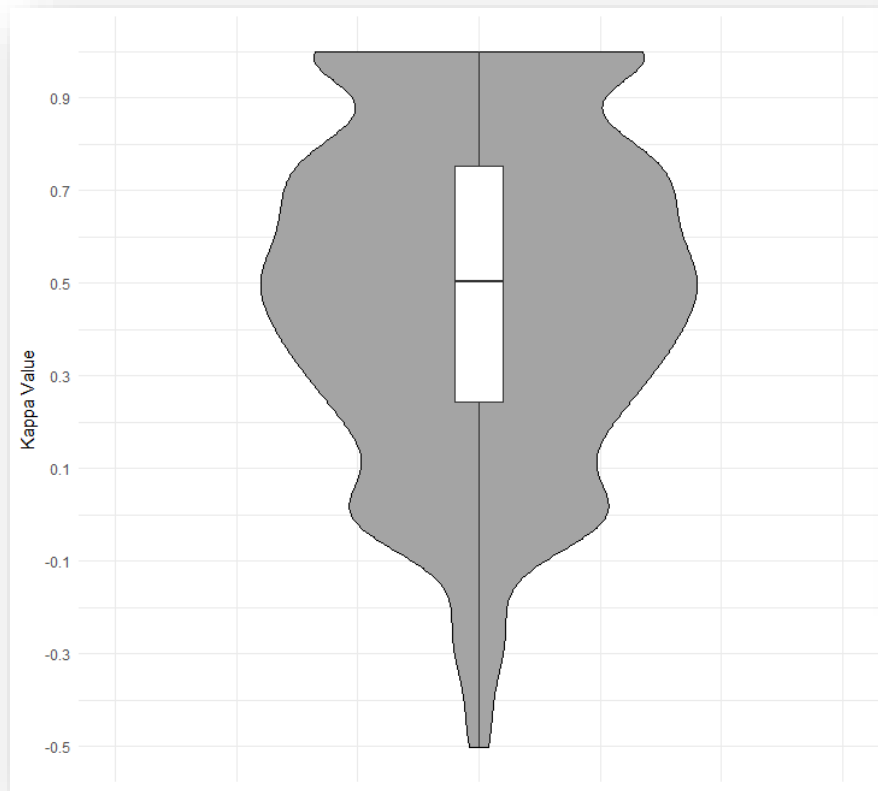

South Sudan

Spatial distribution of agreement per task

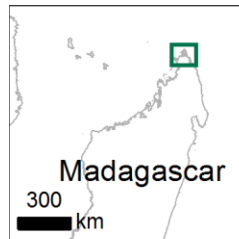

Moran's I: 0.508
Z-Score: 377.488
P-Value: 0.00



Moran's I: 0.442
Z-Score: 244.408
P-Value: 0.00

Agreement

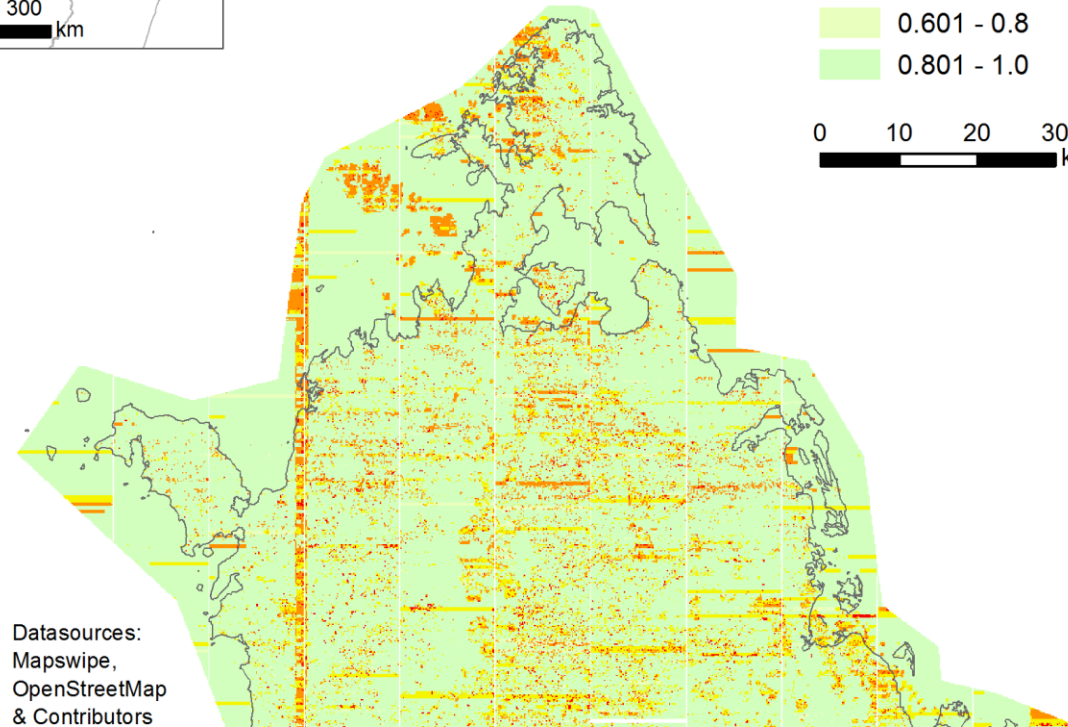
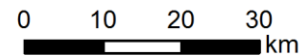
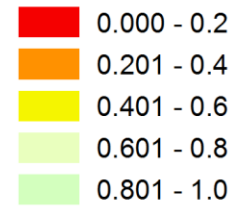

Datasources:
Mapswipe,
OpenStreetMap
& Contributors

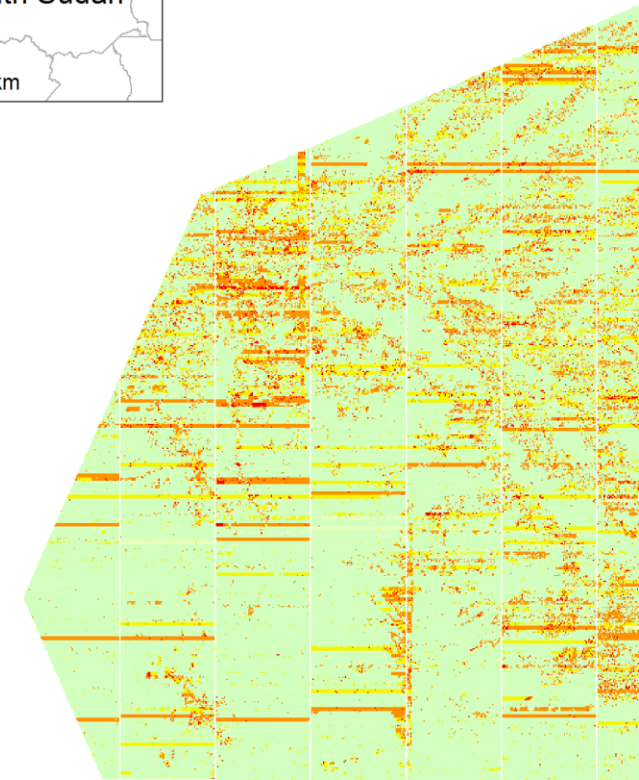

Distribution of different cases of disagreement

		Madagascar		South Sudan	
Case	Name	#	%	#	%
(a)	“Yes-No”	9,439	18.3	23,098	38.9
(b)	“Yes-Maybe”	849	1.6	1,498	2.5
(c)	“Yes-Bad”	601	1.2	661	1.1
(d)	“No-Maybe”	9,230	17.9	11,643	19.6
(e)	“No-Bad”	24,257	47.0	14,969	25.2
(f)	“Maybe-Bad”	1,134	2.2	482	0.8
(g)	“other”	6,077	11.8	7,047	11.9
	total	51,587	100	59,398	100



Spatial distribution of different cases of disagreement

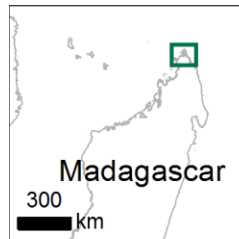

Cases

- Other
- Yes - Maybe
- Yes - Bad
- No - Yes
- No - Maybe
- No - Bad
- Maybe - Bad

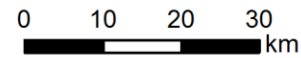

Datasources:
Mapswipe,
OpenStreetMap
& Contributors

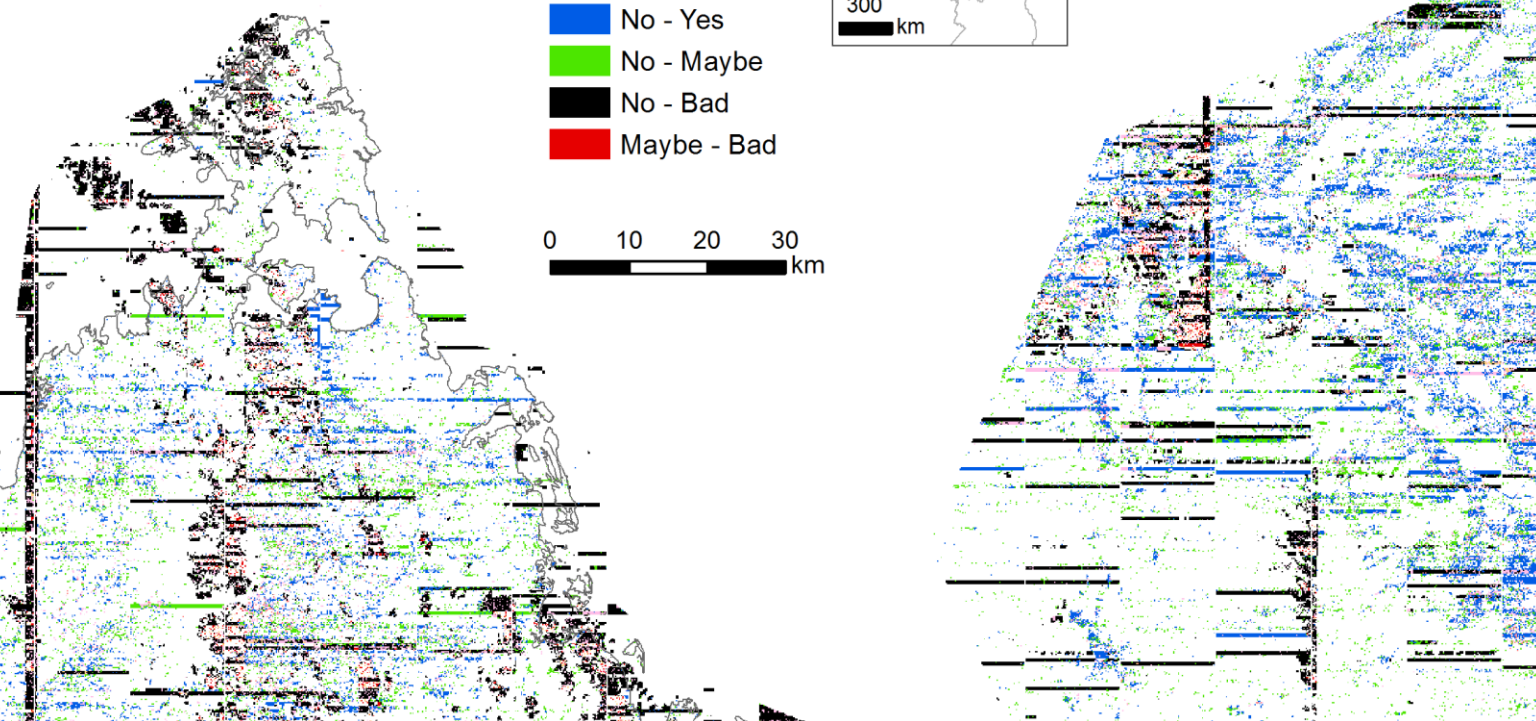

Future work

- Extend analysis for all MapSwipe projects (> 50 projects)
- Derive further intrinsic quality indicators
- Update MapSwipe tasks dynamically using agreement among volunteers
 - Low agreement → more users
 - High agreement → finish task
- Combine MapSwipe data and automated approaches (DeepVGI project)

Thank you for the attention.

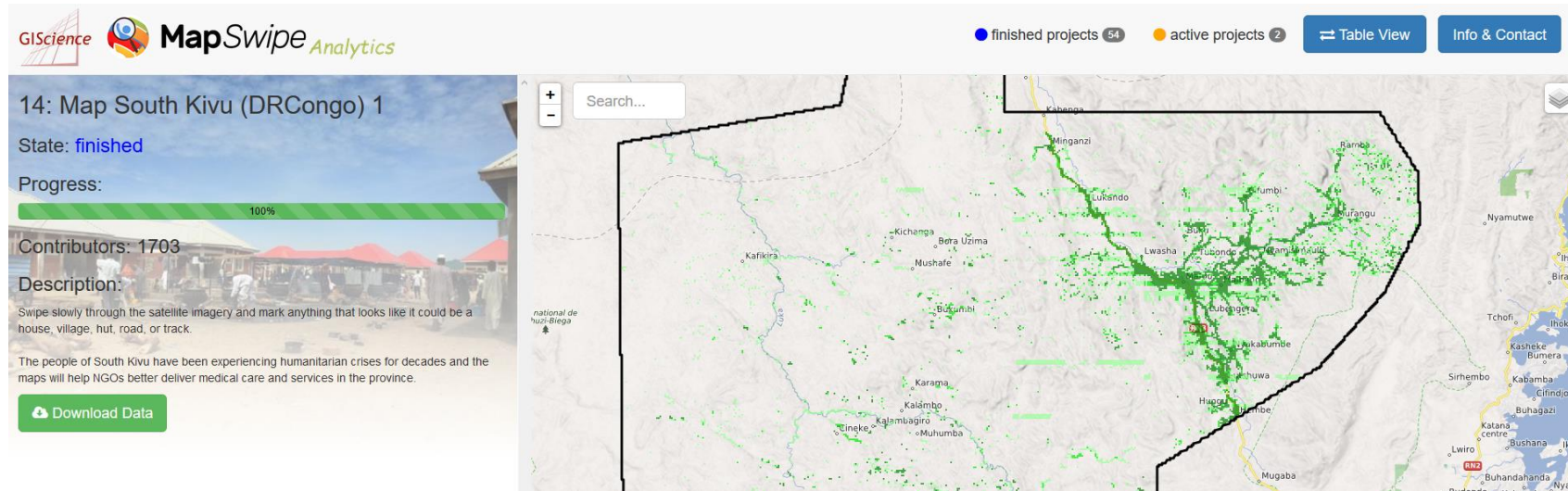

mapswipe.geog.uni-heidelberg.de

herfort@uni-heidelberg.de

